

ULAZNI UREĐAJI

Osnove IKT

Prof. Dr Miroslav Trajanović

IZVORI PODATAKA:

- čovek,
- proces (preko senzora i davača),
- spoljne memorije,
- drugi računarski sistemi.

VRSTA PODATAKA

- KARAKTERI (tekst, brojevi, znakovi)
- SLIKA
- ZVUK
- RADIO ILI TV SIGNAL

VRSTE ULAZNIH UREĐAJA

- Tastature
- Grafički ulazni uređaji
- Video ulazni uređaji
- Audio ulazni uređaji
- Senzori - davači

TASTATURE

- Alfaniumeričke
- Numeričke
- Funkcijske

ALFANUMERICIČKE TASTATURE

■ QWERTY RASPORED



GRAFIČKI ULAZNI UREĐAJI

- Mogu da imaju različite funkcije
 - Lokatori – vraćaju poziciju pokazivača
 - Indikatori – pokazuju na neki element grafičkog interfejsa
 - Valuatori – definišu neku vrednost

MIŠ

Dva senzora mere okretanje kugle u x-y pravcu

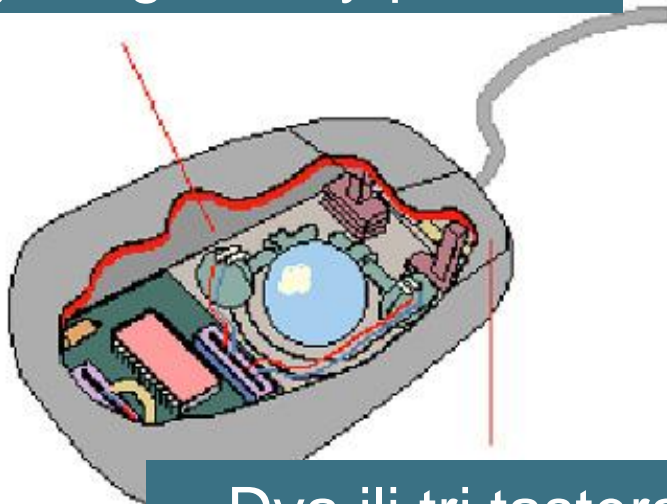

Dva ili tri tastera za izbor



Funkcionisanje mehaničkog miša

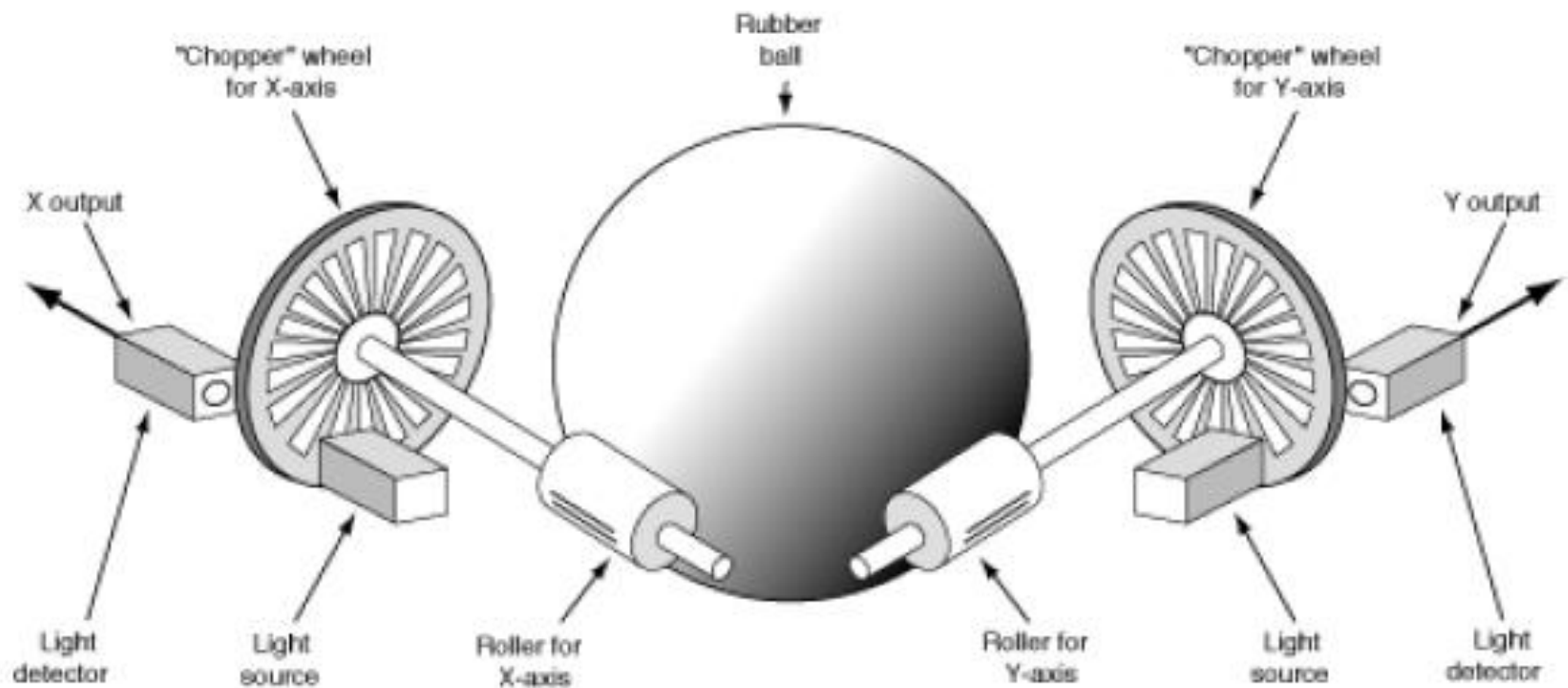

Funkcionisanje optičkog miša



KUGLA - trackball

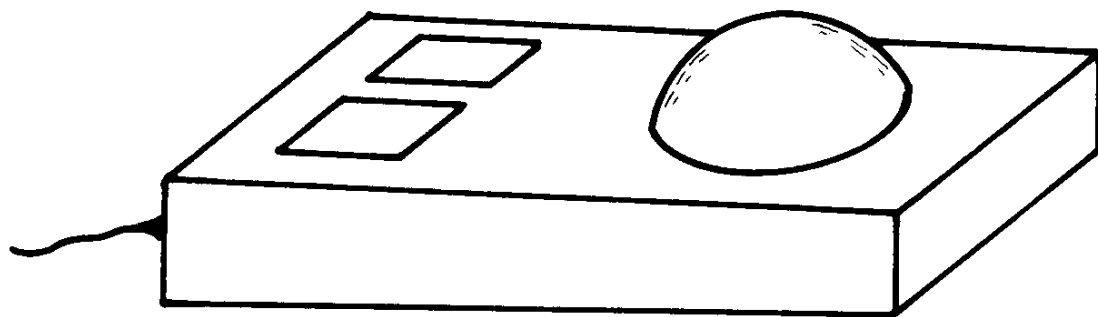
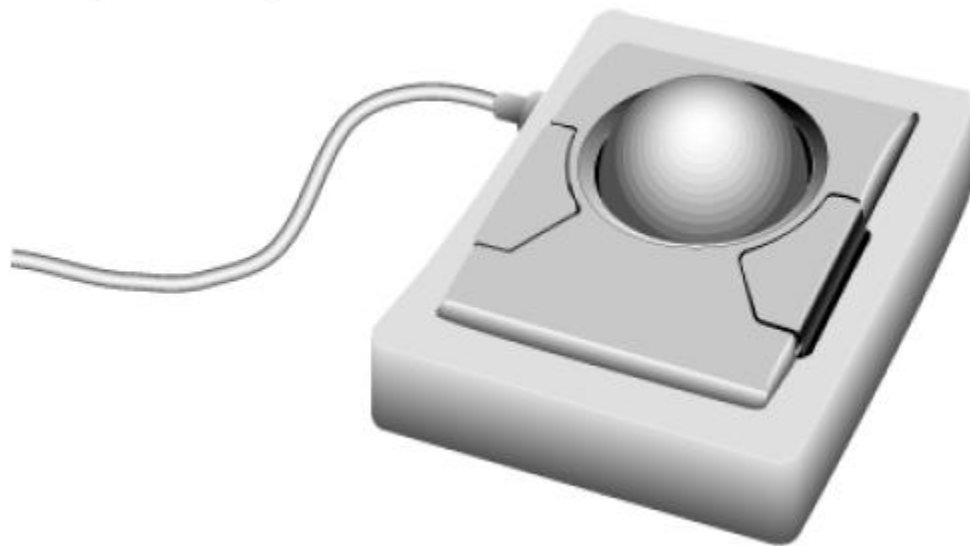

TABLETA



Dr Miroslav Trajanović

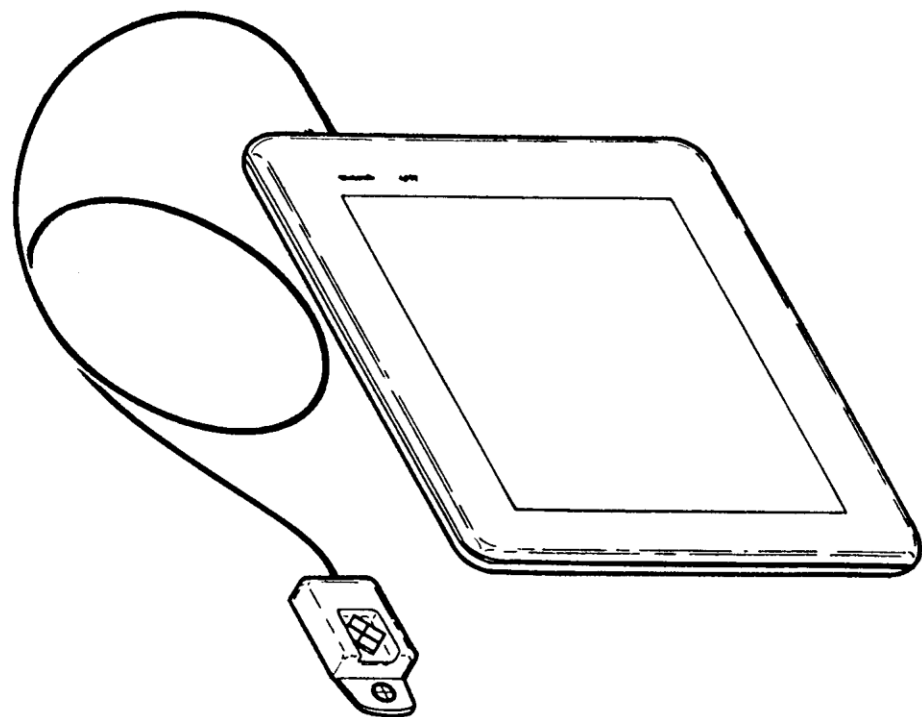

Informaciono komunikacione tehnologije

Ekran osetljiv na dodir

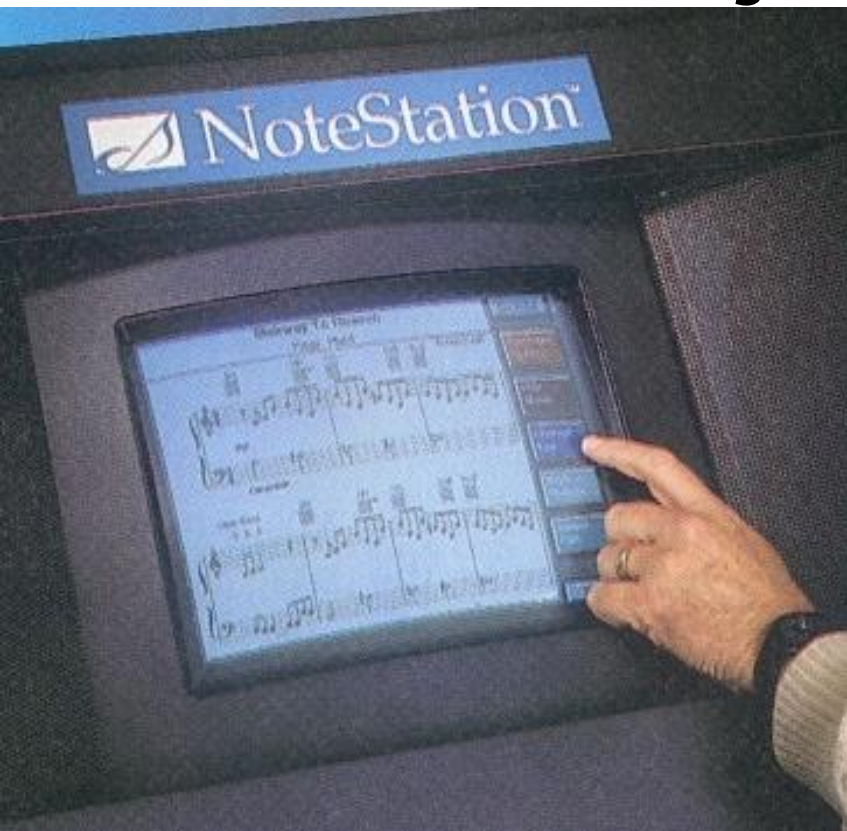

Koriste različite principe:

- Infracrveno svetlo
- Na bazi promene el. Otpora
- Akustični
- Kapacitivni itd.

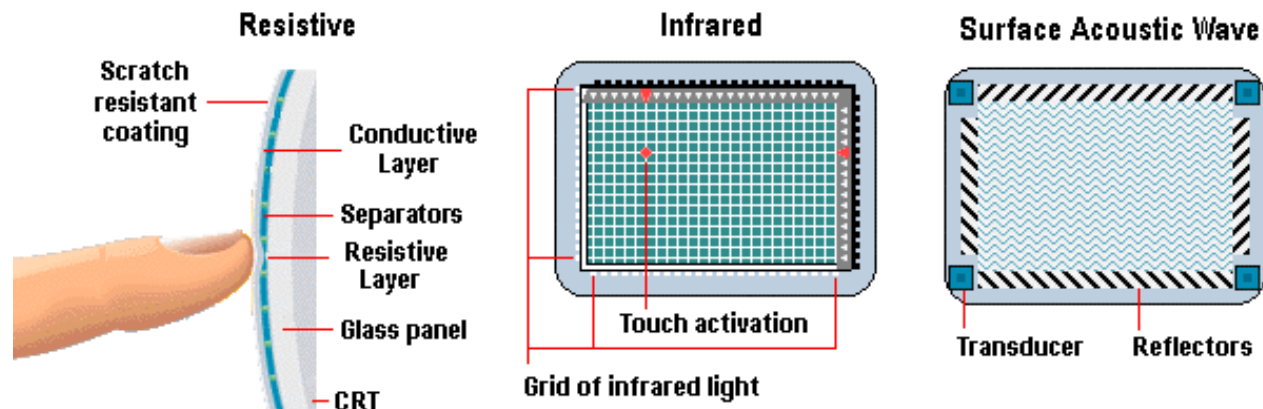

VIDEO ULAZNI UREĐAJI

- Skeneri
- Čitači bar kodova
- Digitalni foto aparati
- Digitalne kamere

Skeneri - Princip rada

Svetlosni izvor osvetljava papir
Bela područja reflektuju više svetlosti

Glava skenera se pomera ispod papira
i prima svetlost reflektovanu od papira

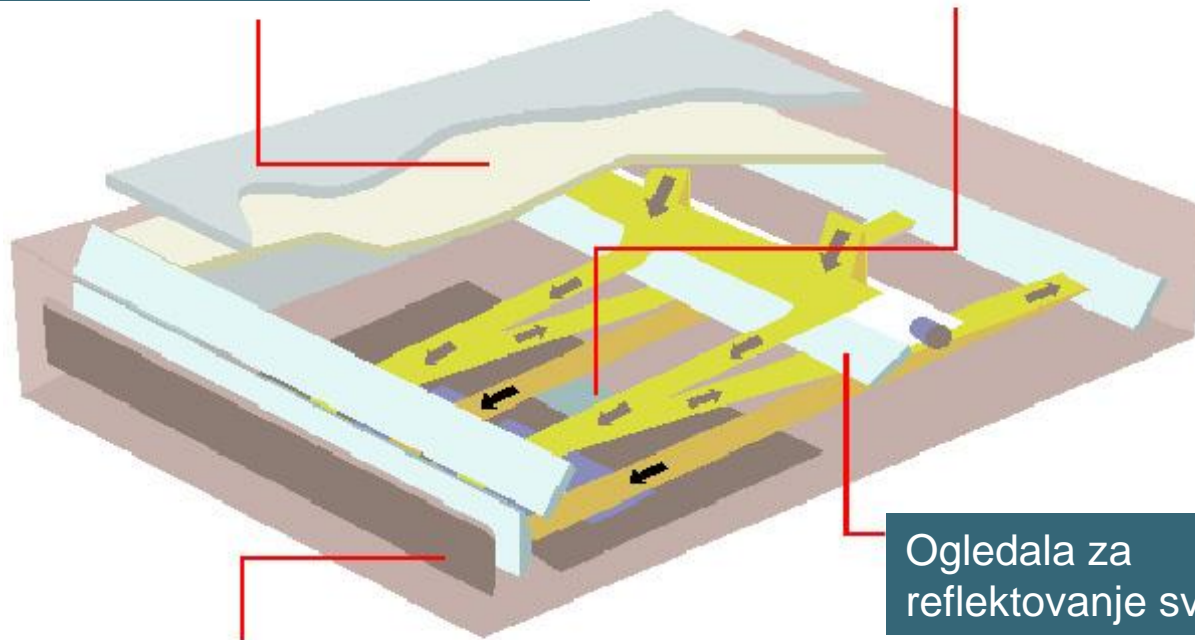

Ogledala za
reflektovanje svetlosti

Sočivo prihvata svetlost i šalje ga
foto osetljivim diodama koji ga pretvaraju
u električne signale

RUČNI SKENER



STONI SKENER

ScanJet 6200 HP

CCD - Charged Coupled Device (*Uređaj sa spregnutim naelektrisanjem*)



ČITAČI BAR KODA

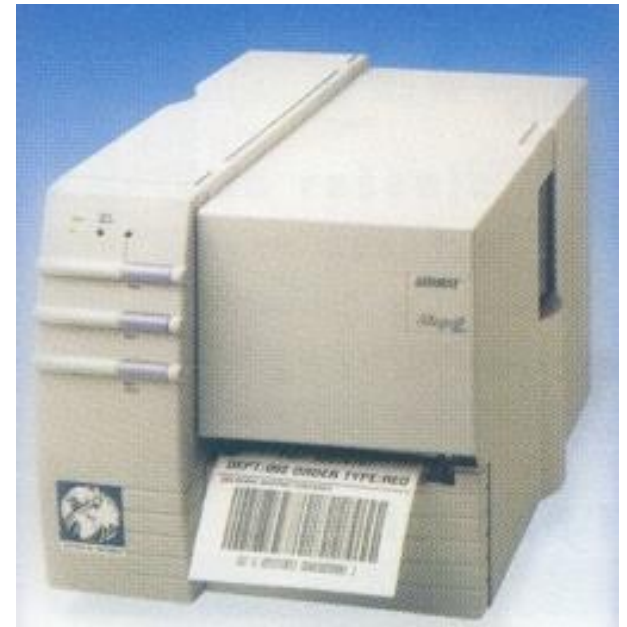
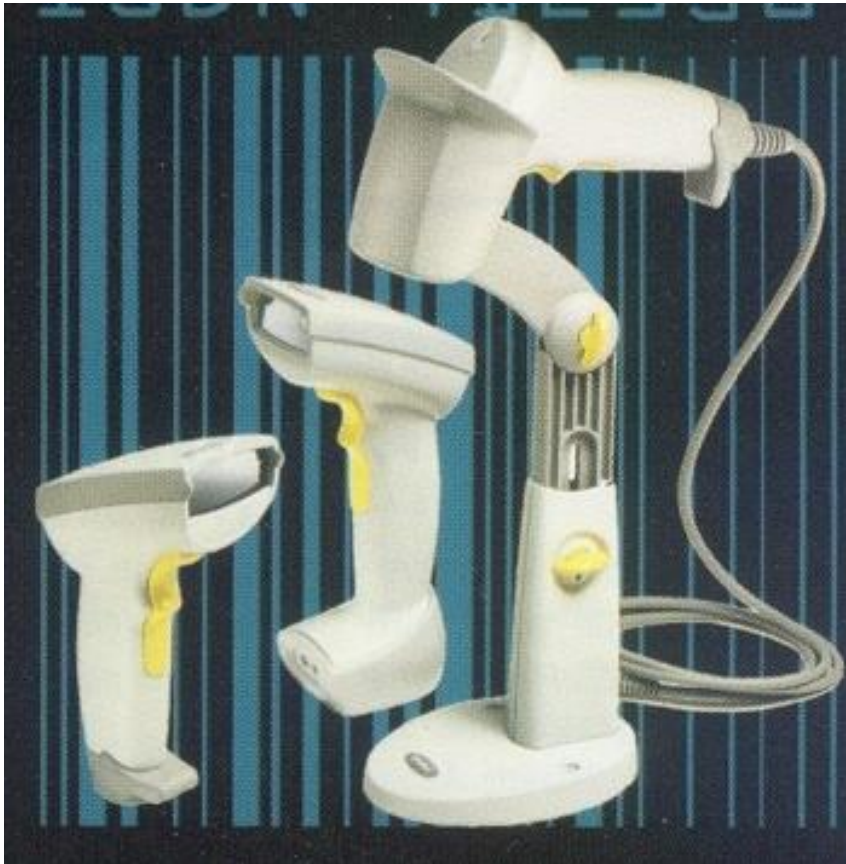

XYZ AIRFREIGHT CO.



* SEA 5794 4PCS 86.4KG *

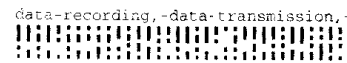

0123456789
ABCDEFGHIJ

1 2 3 4
H Y
d P H O



8151-054100

⑈122000043⑈2627-090-012038⑈

Čitači bar koda

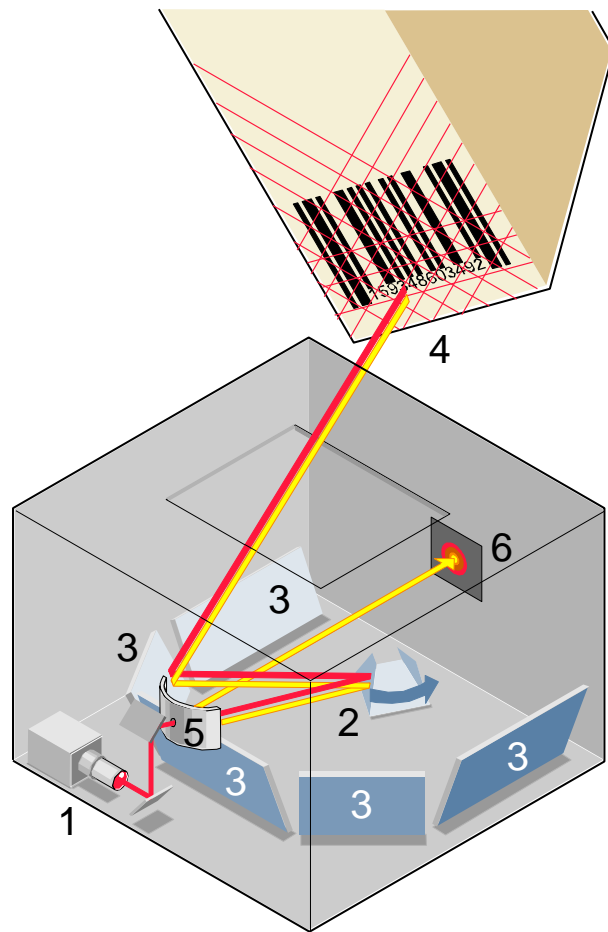

Projected laser beam

Reflection

Bar code

Electrical signal

Digital code

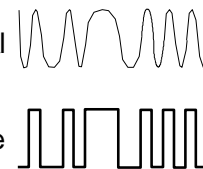

DIGITALNI FOTO APARAT

- Rezolucija 2.1 MP (1632x1232)
- Zum 3x optički, 4x digitalni, ukupno 12x
- Memorijska kartica 8 do 512 MB
- JPEG kompresija
- LCD displej
- Rezolucija 3.34 MP (2140x1560)
- Rezolucija 12.4 MP (4288x2848)



DIGITALNI FOTO APARAT

- Objektiv fokusira svetlo na CCD
- CCD (Charge Coupled Device) senzor pretvara svetlost u električni napon u svakoj tački (piksel)
- A/D pretvarač pretvara napon u cifre
- Mikroprocesor obrađuje sliku
- Fleš memorija

DIGITALNA KAMERA



AUDIO ULAZNI UREĐAJI

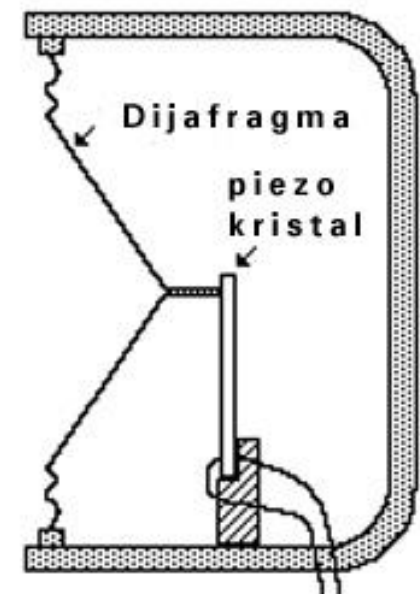
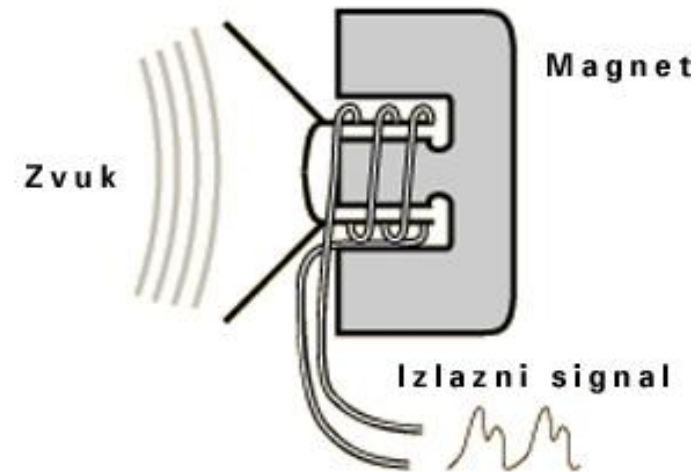

IZLAZNI UREĐAJI

Osnove IKT

Dr Miroslav Trajanović

IZLAZNI UREĐAJI

Oni delovi računarskog sistema na koje se šalju podaci radi:

- Izdavanja
- Prikazivanja ili
- Emitovanja

FORMA IZLAZNIH PODATAKA

- MAŠINSKI ČITLJIVI
 - Spoljnim memorijama
 - Drugim računarskim sistemima
 - Procesima
- LJUDSKI ČITLJIVI

UREĐAJI ZA IZDAVANJE PODATAKA

- Trajan zapis podataka (hard copy)
- Obično na papiru
- Tekst i slike

UREĐAJI ZA IZDAVANJE PODATAKA

- Štampači - printers
- Crtači - plotters

ŠTAMPAČI

- Sa udarom
 - Serijski (štampaju slovo po slovo)
 - Linijski (štampaju odjednom celu liniju)
- Bez udara
 - Termički
 - Laserski
 - Sa nanošenjem boja

LEPEZASTI ŠTAMPAČI

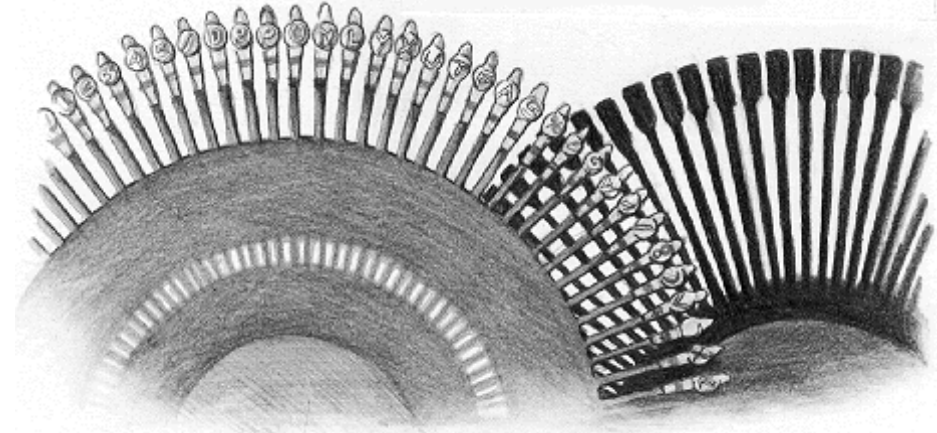
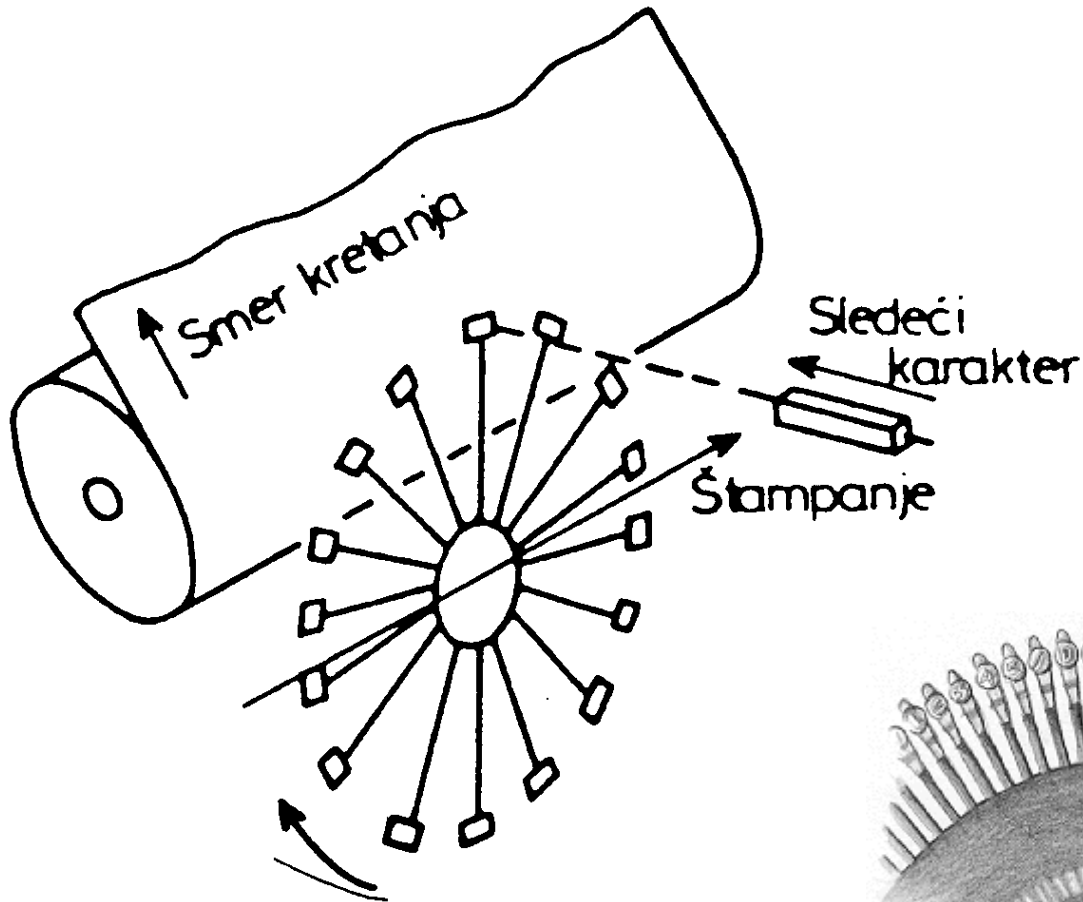

MATRIČNI ŠTAMPAČI

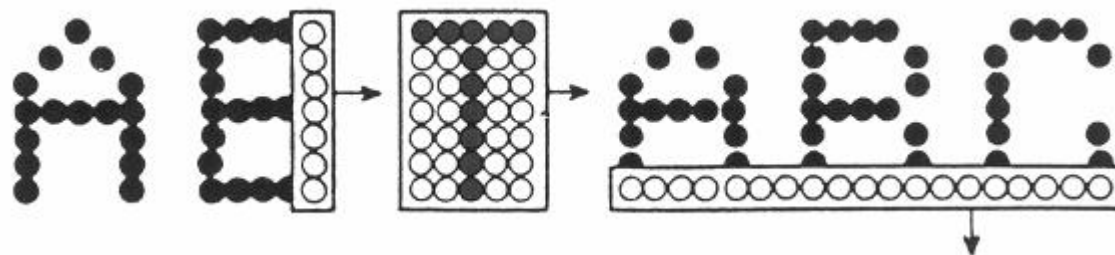
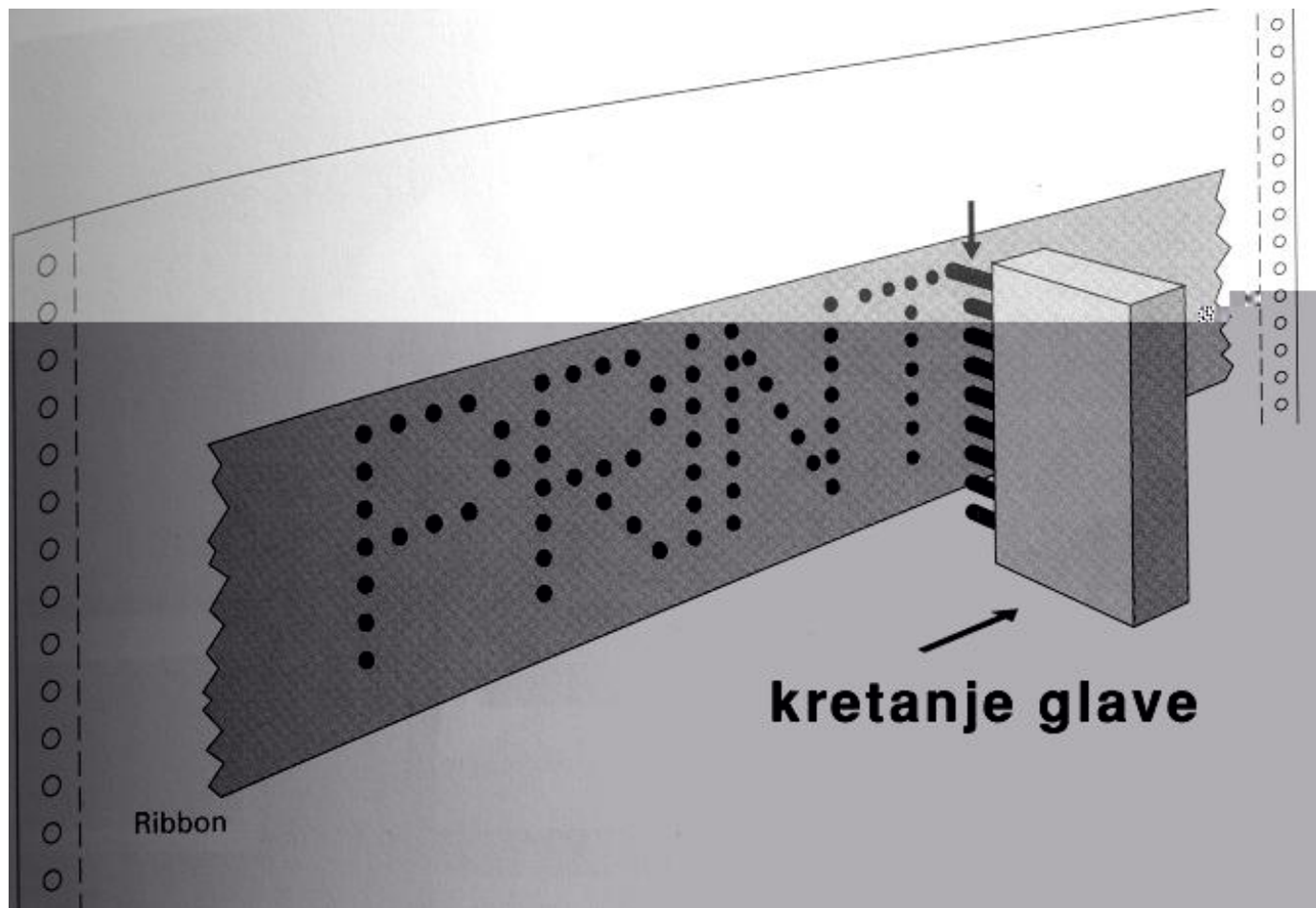

MATRIČNI ŠTAMPAČI

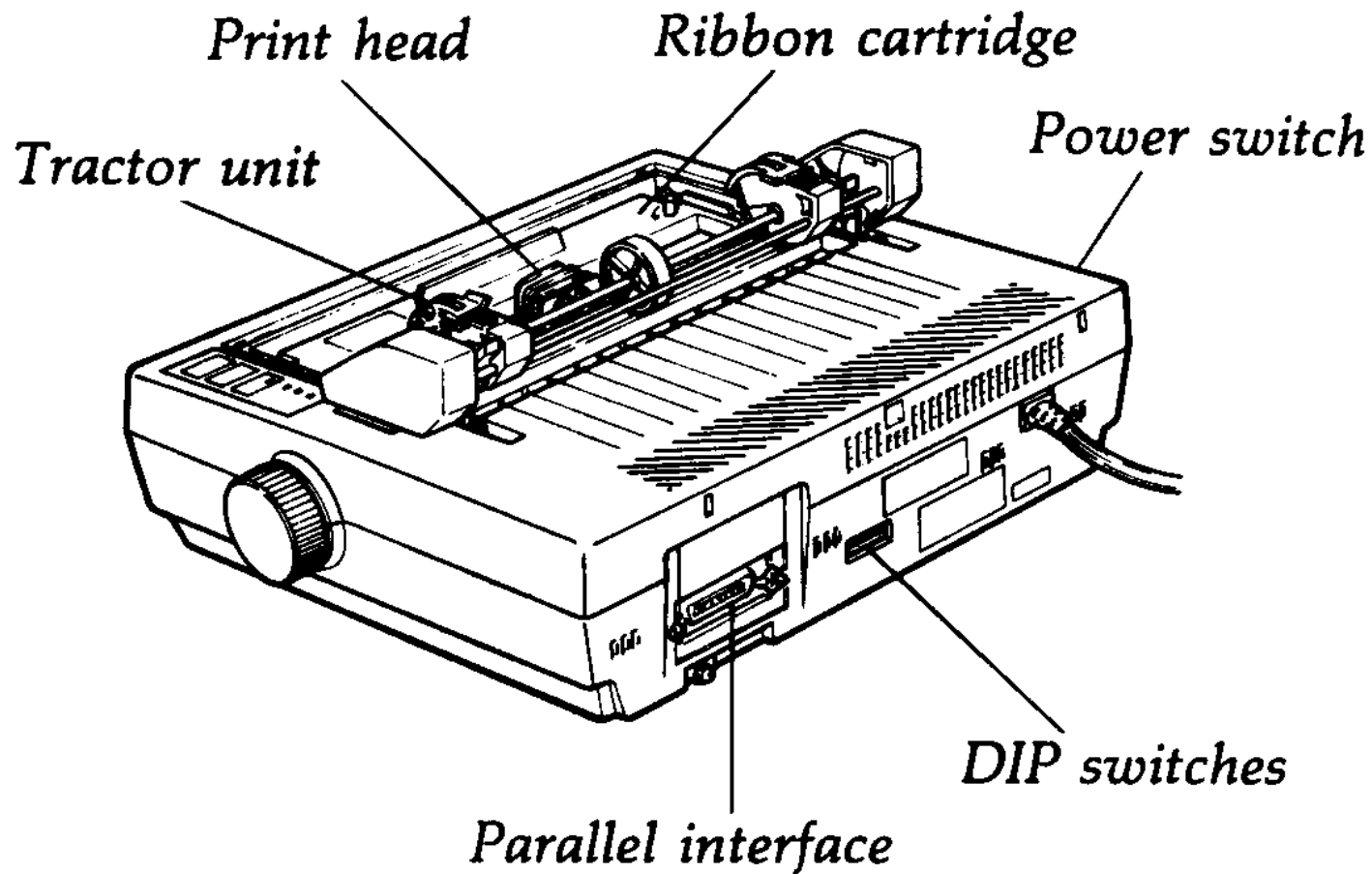

MATRIČNI ŠTAMPAČI

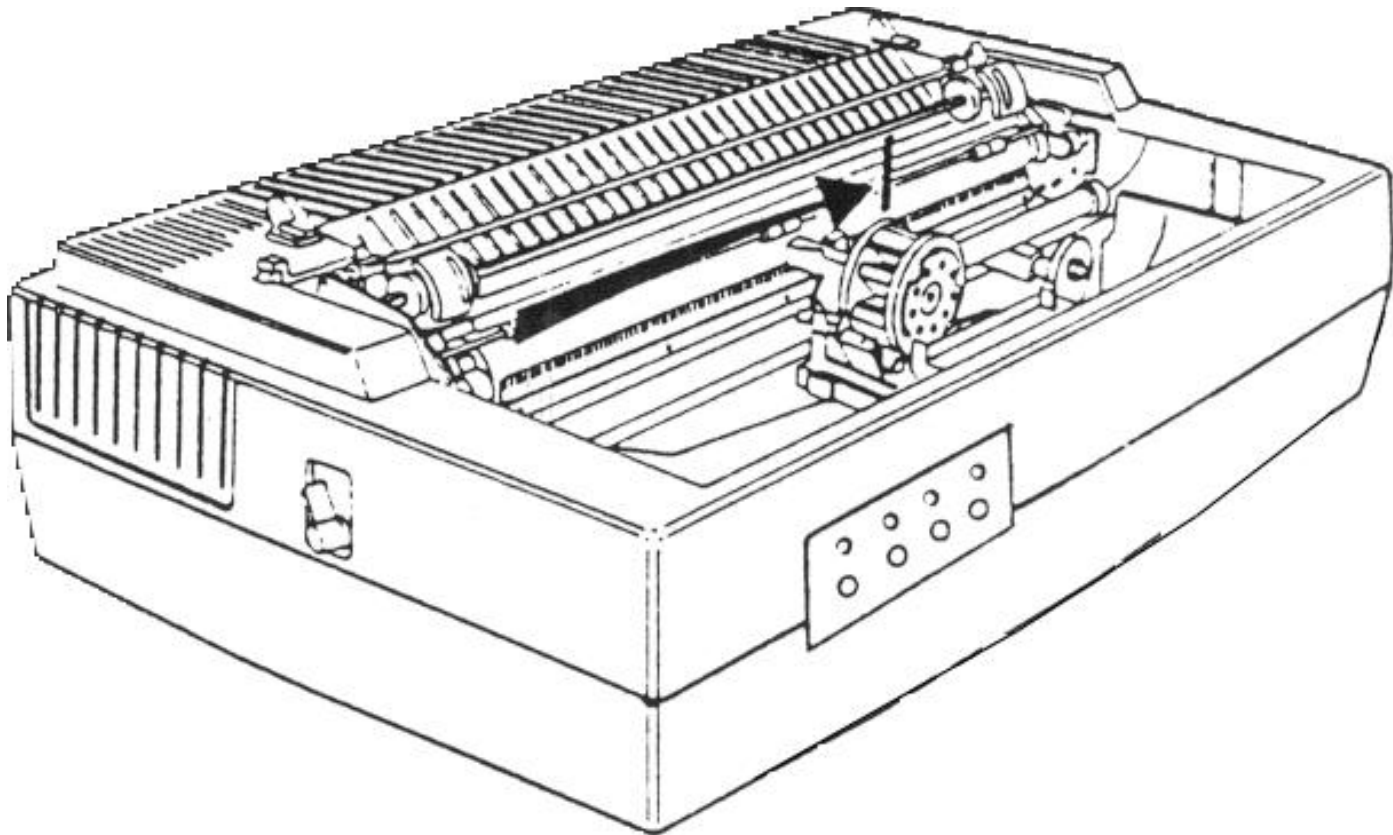

EPSON Matricni stampac LX-300+

- Matricni 9-pinski štampac
- Emulacija: EPSON ESC/P2 i IBM 2380
- 337cpm (12cpi High speed draft)
- 67 cps (12 cpi NLQ)
- Ugradjen vucni i gurajuci traktor
- Širina papira od 101.6mm do 254mm
- Debljina papira od 0.065mm do 0.39mm
- Do 1+4 kopija
- Interni bafer 8KB
- Paralelni i serijski interfejs
- Buka do 49 dB
- Maksimalna potrošnja 23W
- Opciono za LX-300+: kolor kertridž

MATRIČNI ŠTAMPAČI

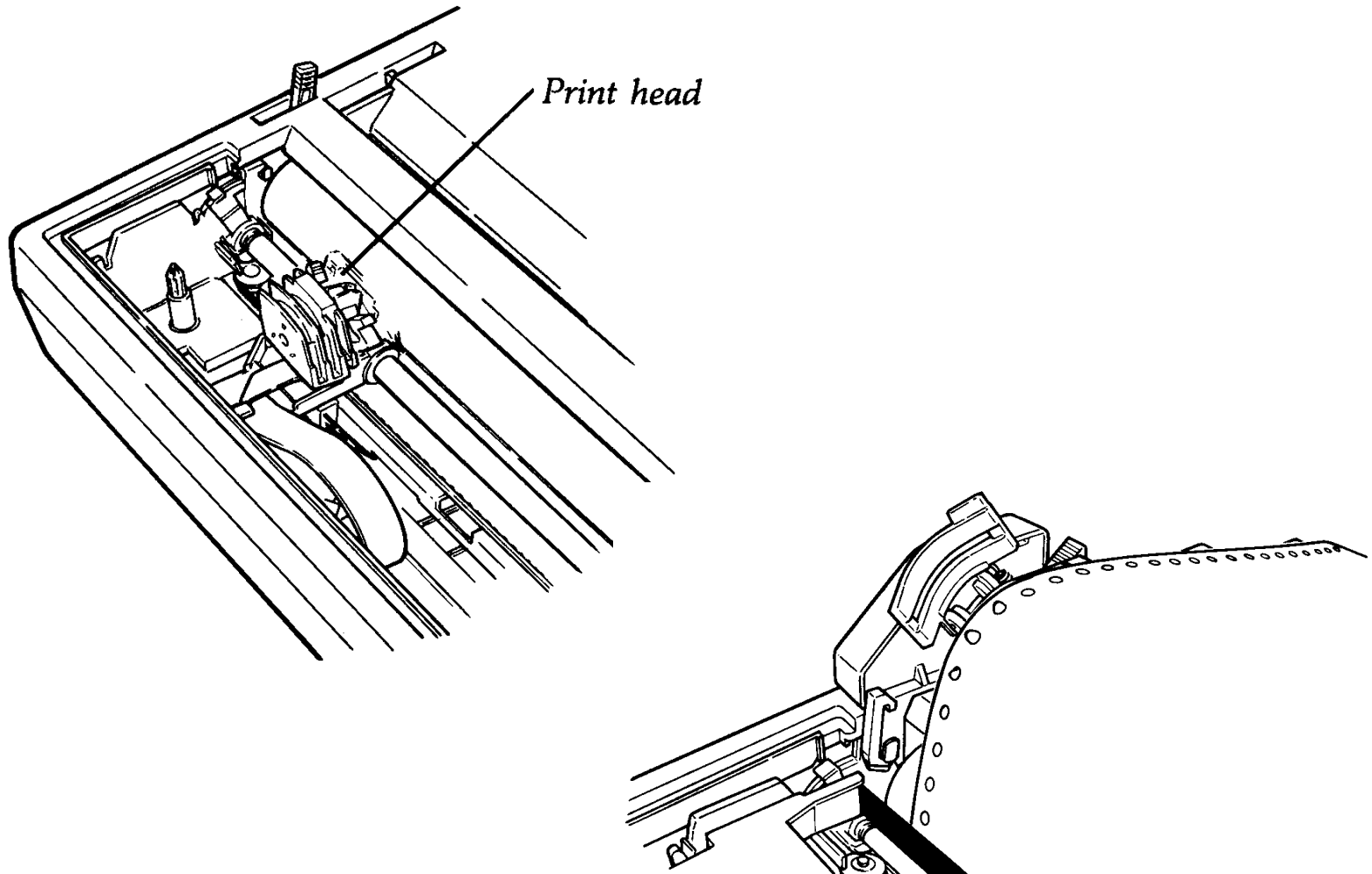

LINIJSKI ŠTAMPAČI

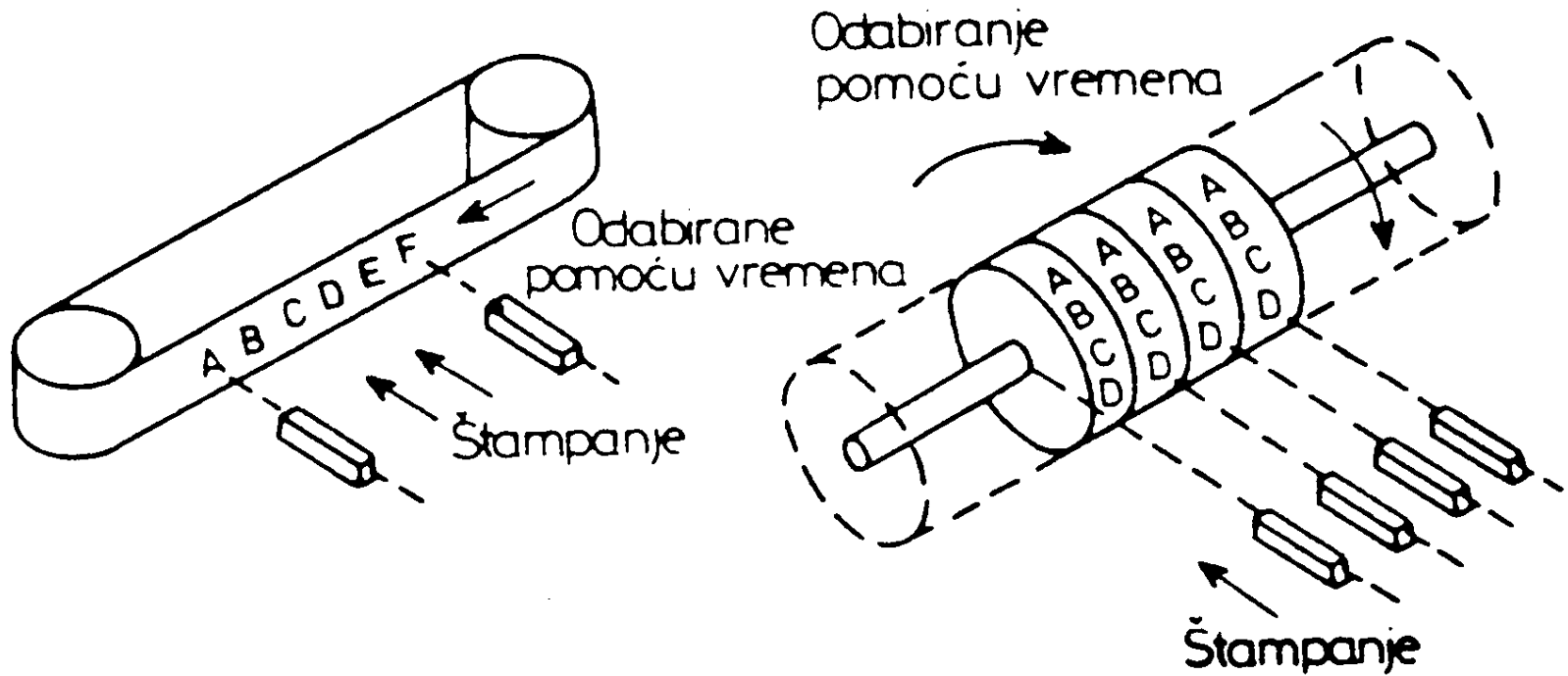

TERMIČKI ŠTAMPAČI

- Specijalni termo papir
- Primena kod telefaksa
- Otisak blede sa vremenom

LASERSKI ŠTAMPAČI

- 1984 Hewlett Packard na Canon tehnologiji
- Laserski zrak vrši elektrostatičko naelektrisanje selenskog valjka
- Naelektrisana mesta privuku toner
- Maksimalna rezolucija 1200x1200 dpi

Princip rada laserskih štampača

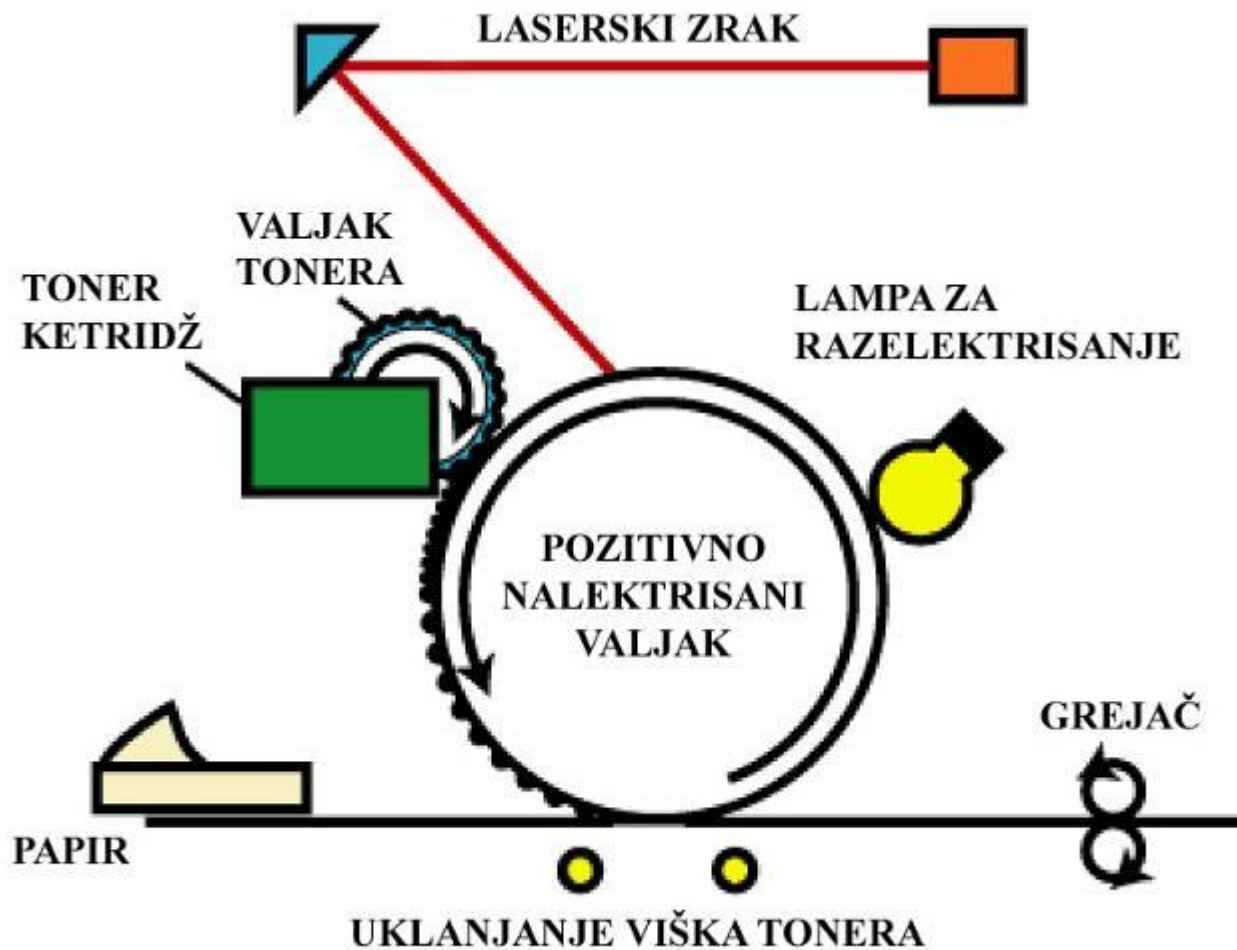
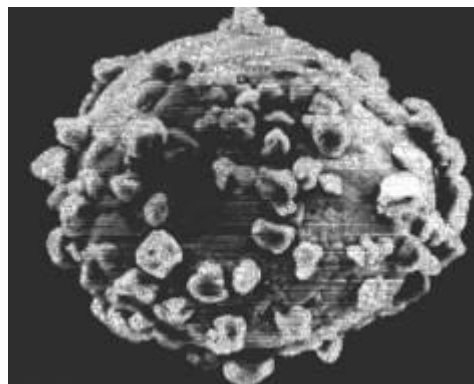

Princip rada laserskih štampača

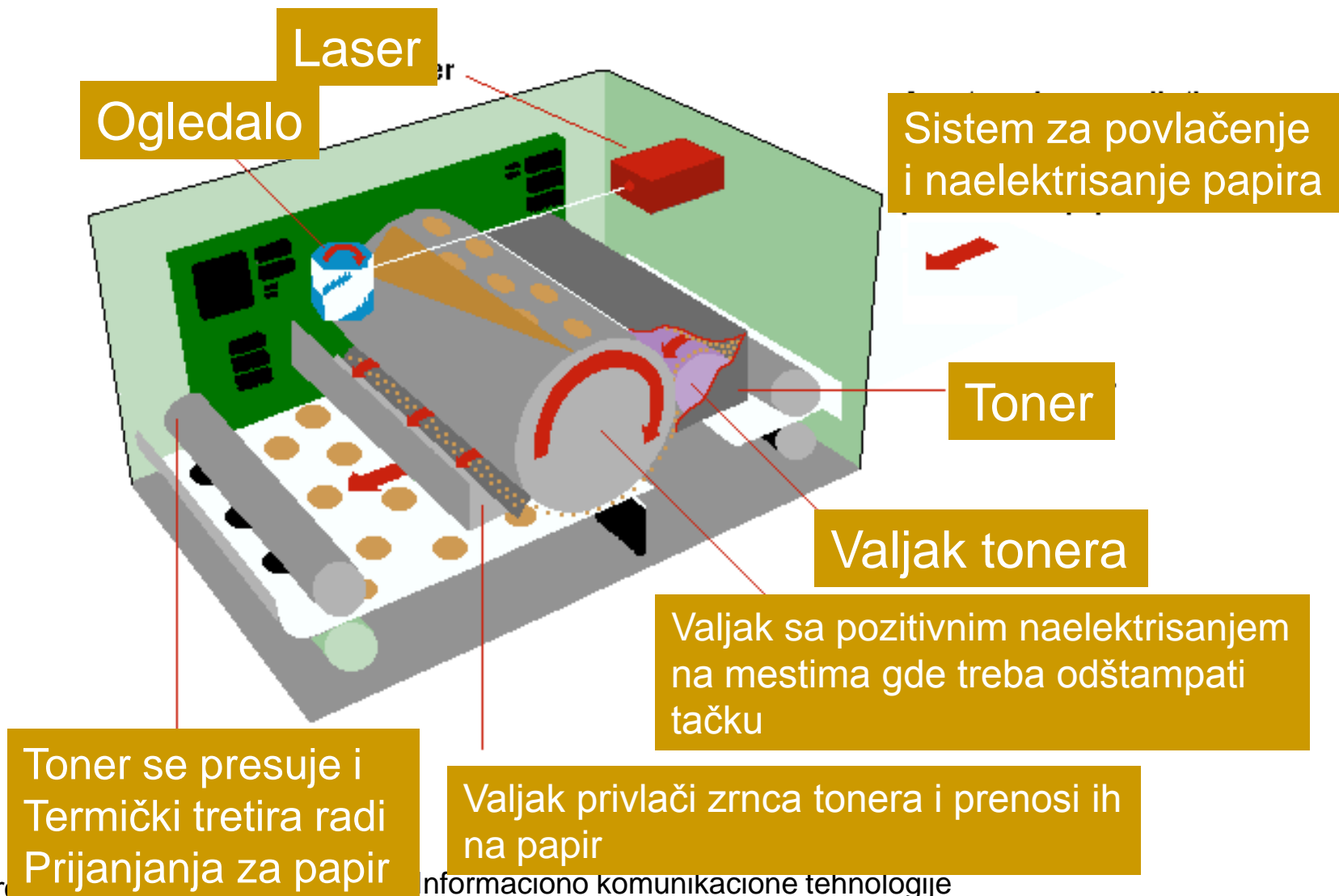

REZOLUCIJA

- Broj tačaka po inču – Dot per Inch –DPI
- Za A4 papir sa 600x600 DPI 33.660.000 tačaka



LASERSKI ŠTAPAČI

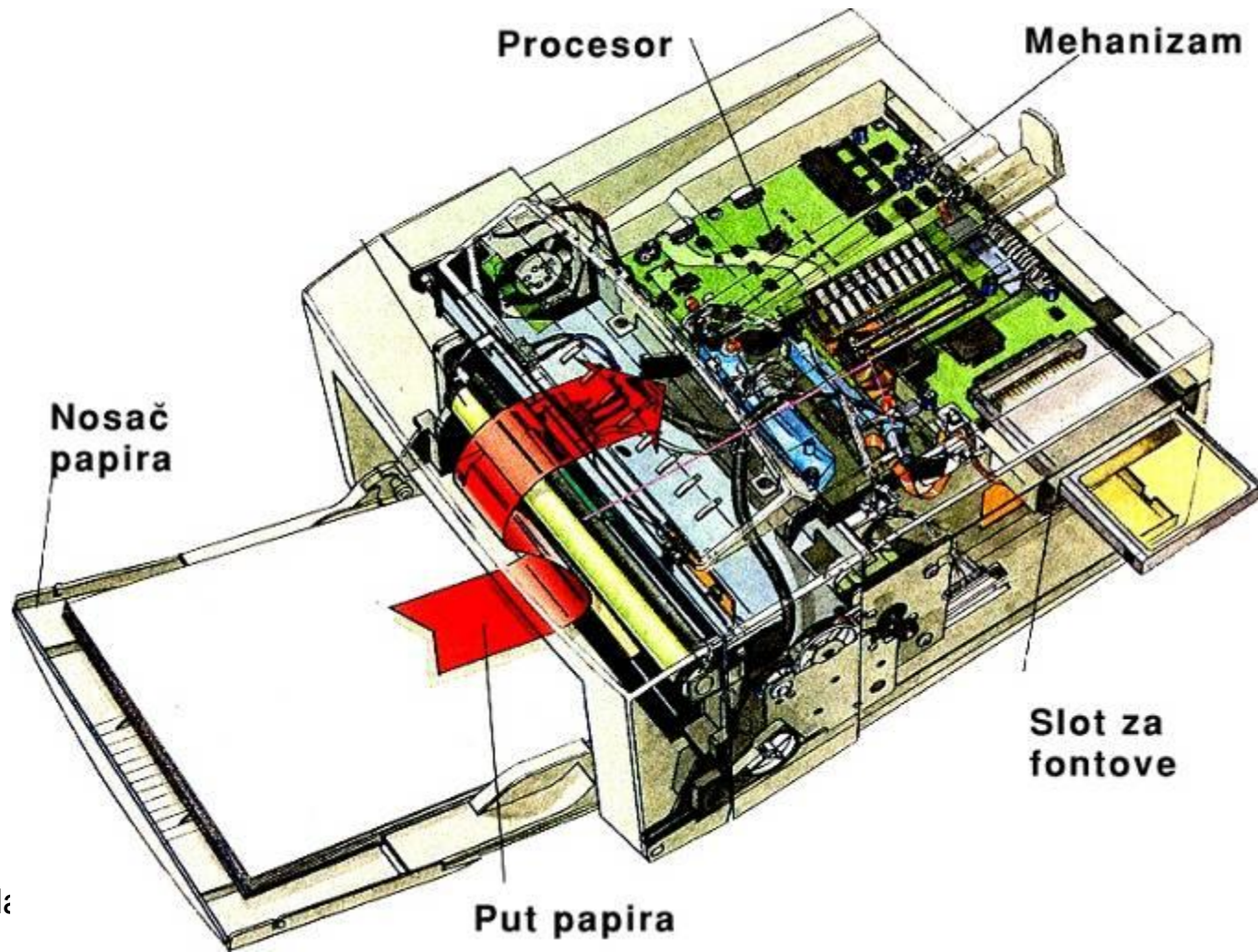

ŠTAMPAČI SA NANOŠENJEM BOJA

- Štampači sa mlazom mastila
- Štampači sa voskom

ŠTAMPAČI SA MLAZOM MASTILA

- Ink jet
- Crno beli i kolor
- Termičke ili piezoelektrične mlaznice
- Rezolucija 1200X1200 DPI
- Broj mlaznica: 304 crnih i 912 kolor

Princip rada

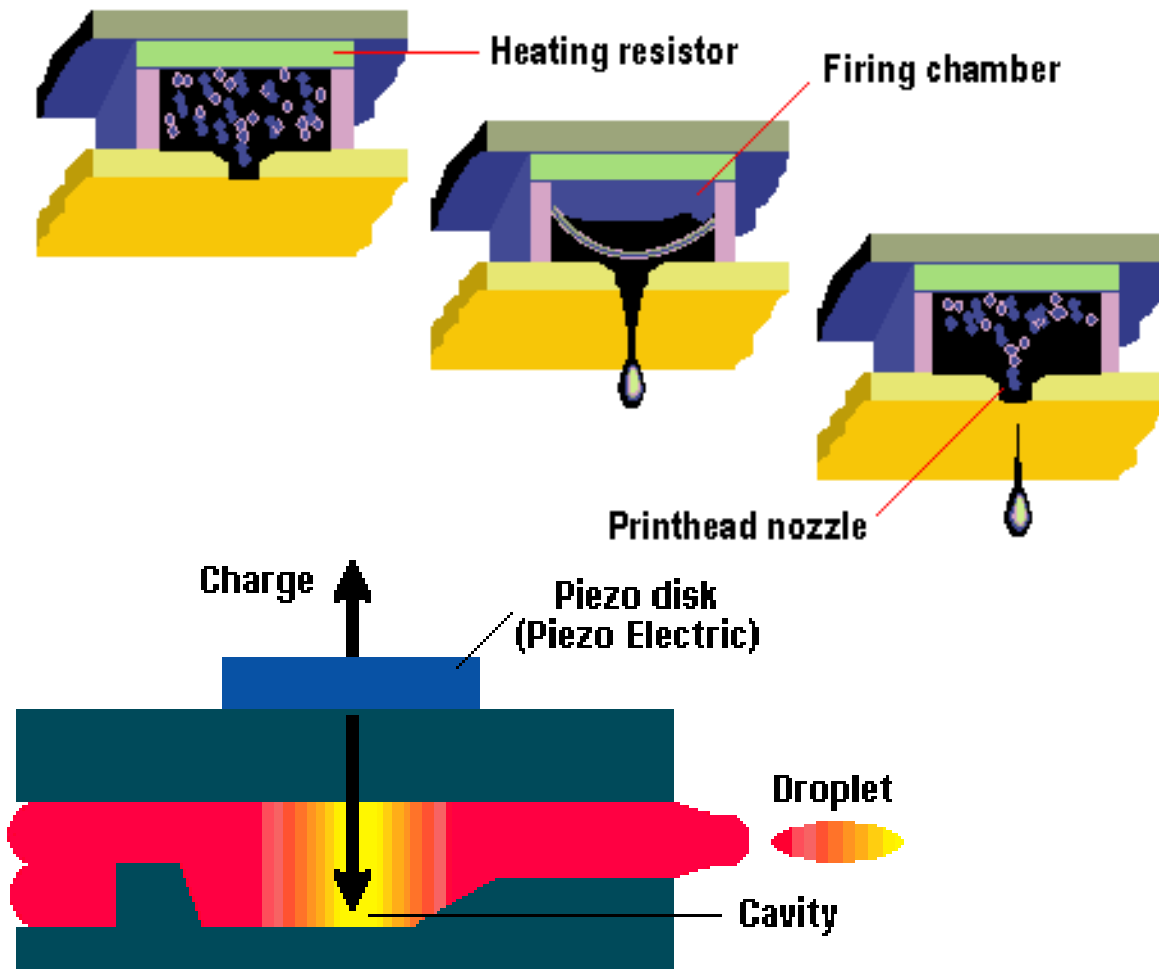

INK JET ŠTAMPAČ



Hewlett-Packard HP DeskJet 1220C

- Color Inkjet štampač
- Maksimalna rezolucija: 1200x2400 dpi (na Photo papiru)
- Brzina štampanja: 11/9,5 strana u minuti (crna/color A4; draft mod)
- Format papira: do A3
- Način štampe: Termalni InkJet
- Mesečni obim štampanja: do 5000 stranica
- Interni bafer: 8MB
- Crni i kolor kertridz sa integrisanom glavom za štampanje
- REt III i ColorSmart III tehnologije optičkog povećanja kvaliteta štampe



MULTI FUNKCIJSKI UREĐAJ

- Štampač
- Skener
- Fax
- Foto-kopiranje

■ LEXMARK X125



CRTAČI

- Sa pisaljka
- Ink jet

Crtači sa pisaljkama

■ Vektorska grafika

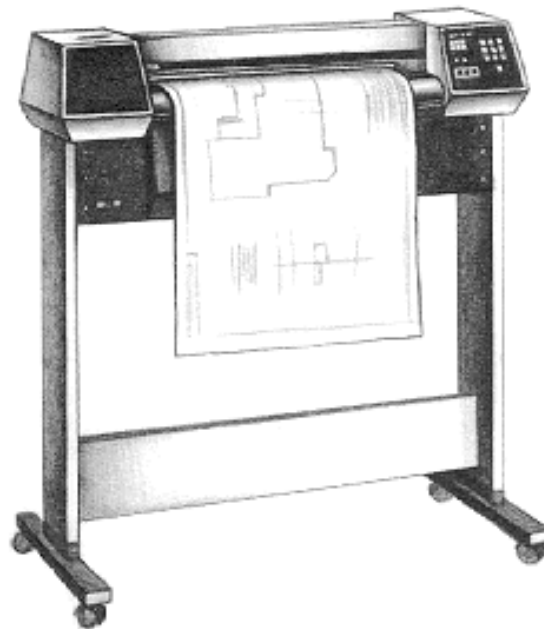

INK JET PLOTER

- Rasterska grafika



UREĐAJI ZA PRIKAZ PODATAKA

- Privremeno prikazivanje podataka na nekoj vrsti displeja
- Dužina prikaza se može kontrolisati

VEKTORSKI I RASTERSKI DISPLEJI

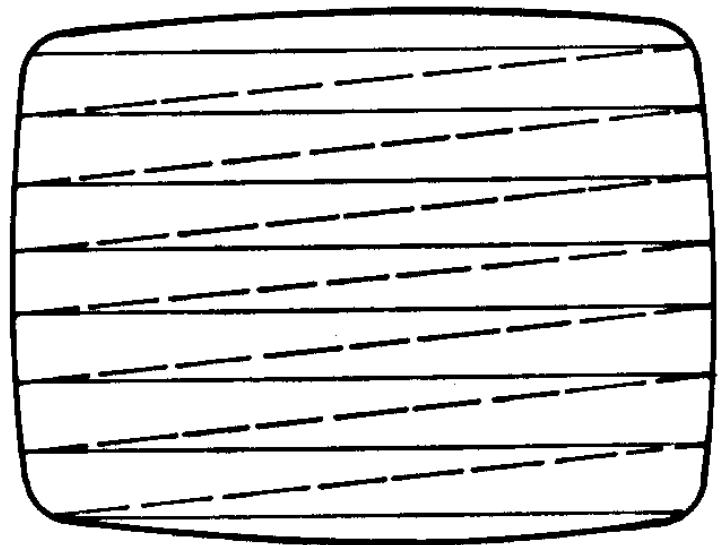
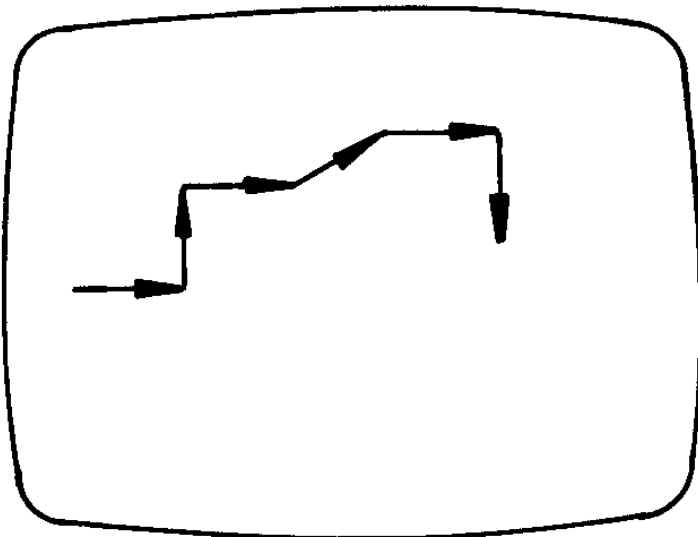
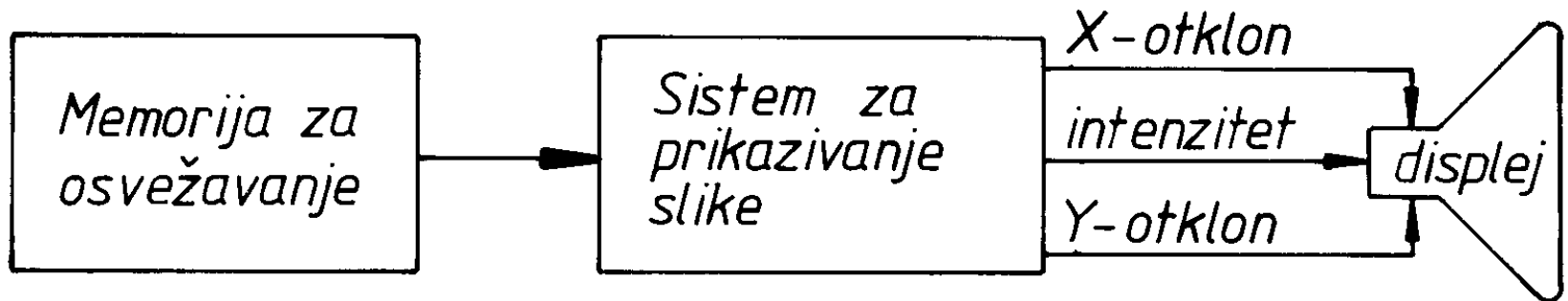

KATODNA CEV

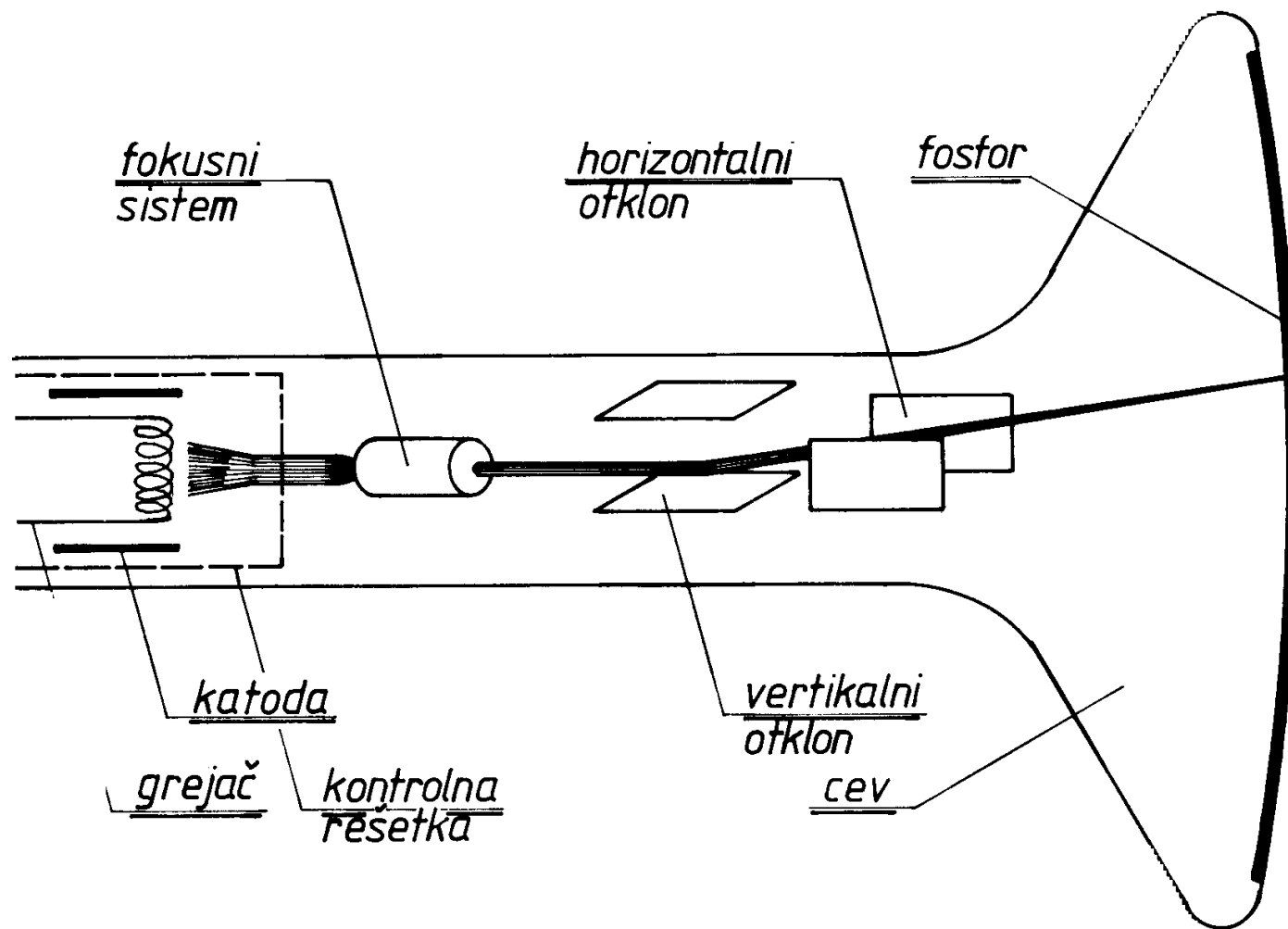

KOLOR KATODNA CEV

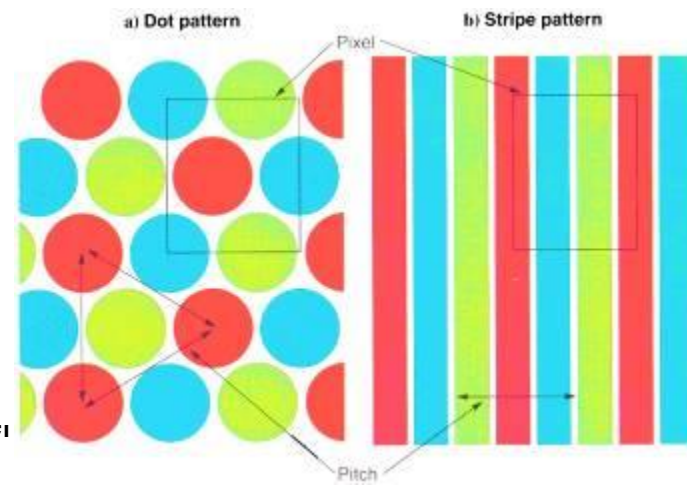
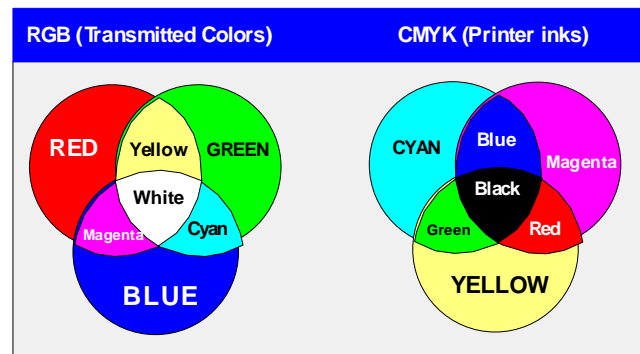
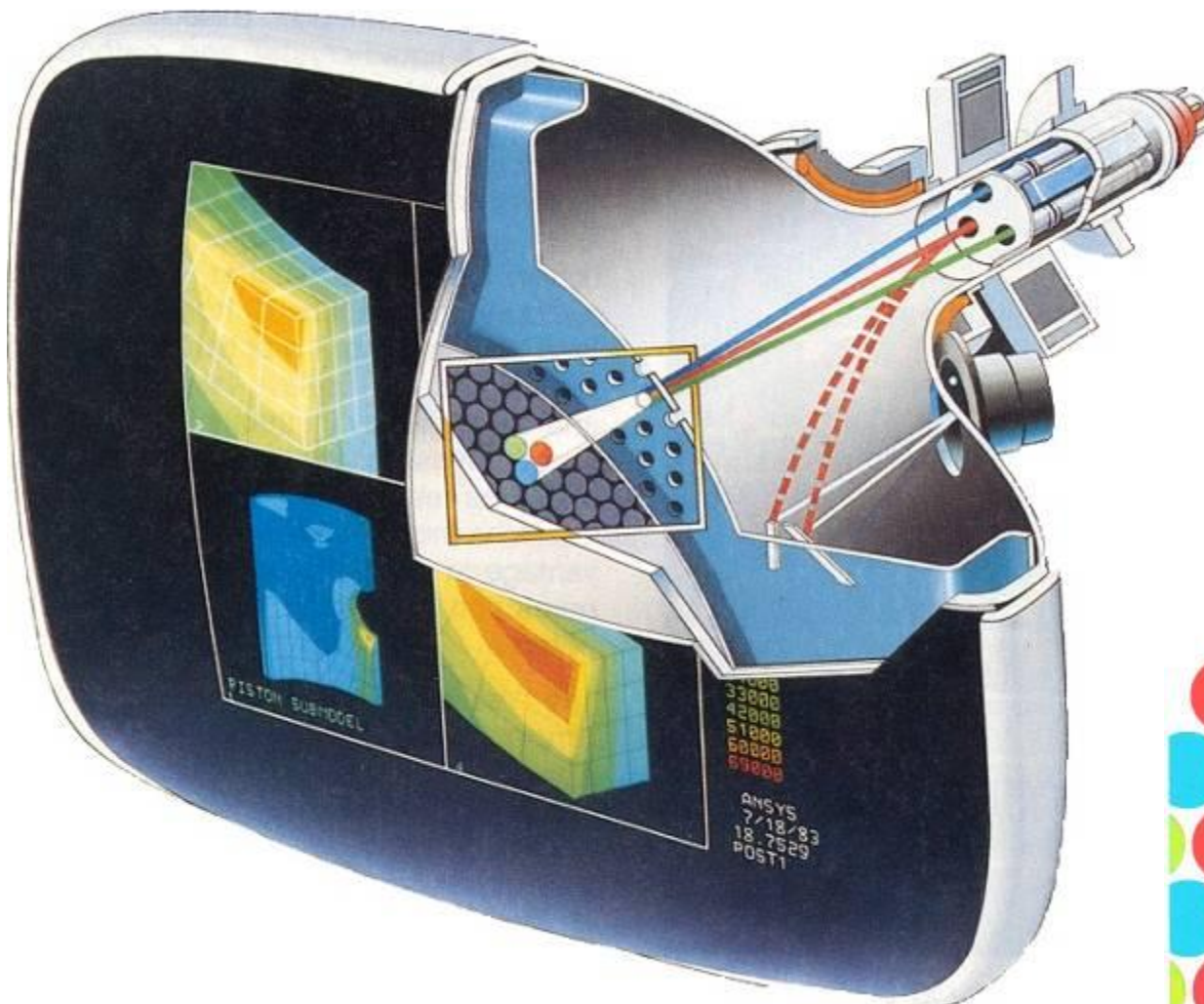

VIDEO KARTICA

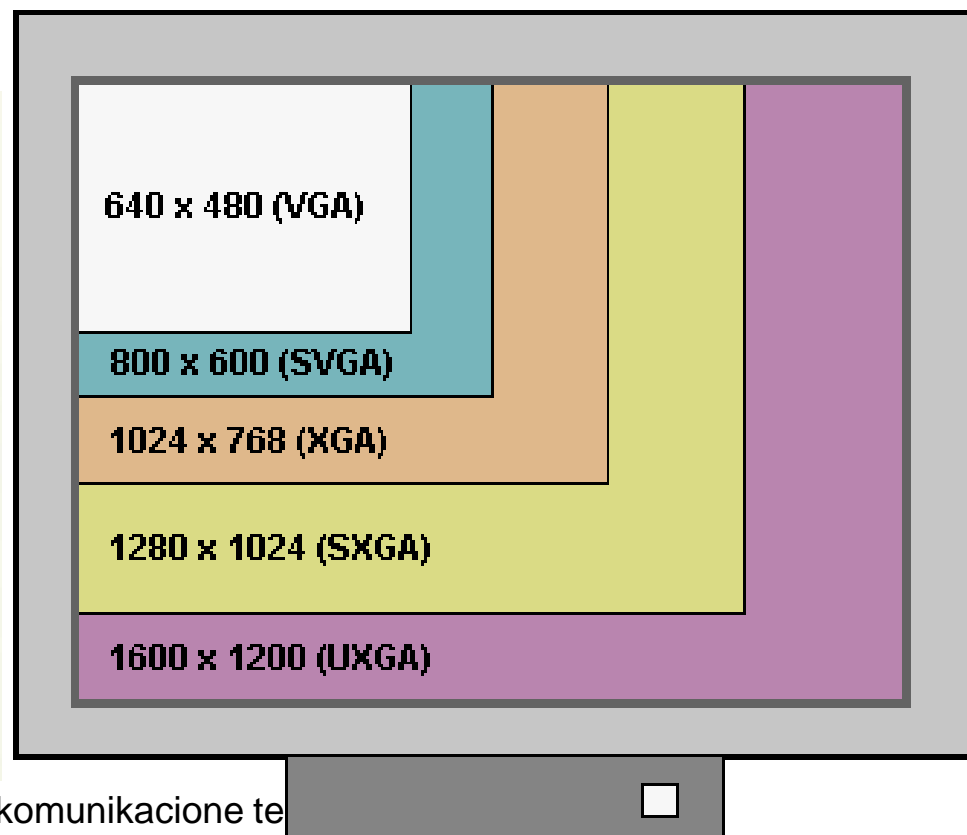
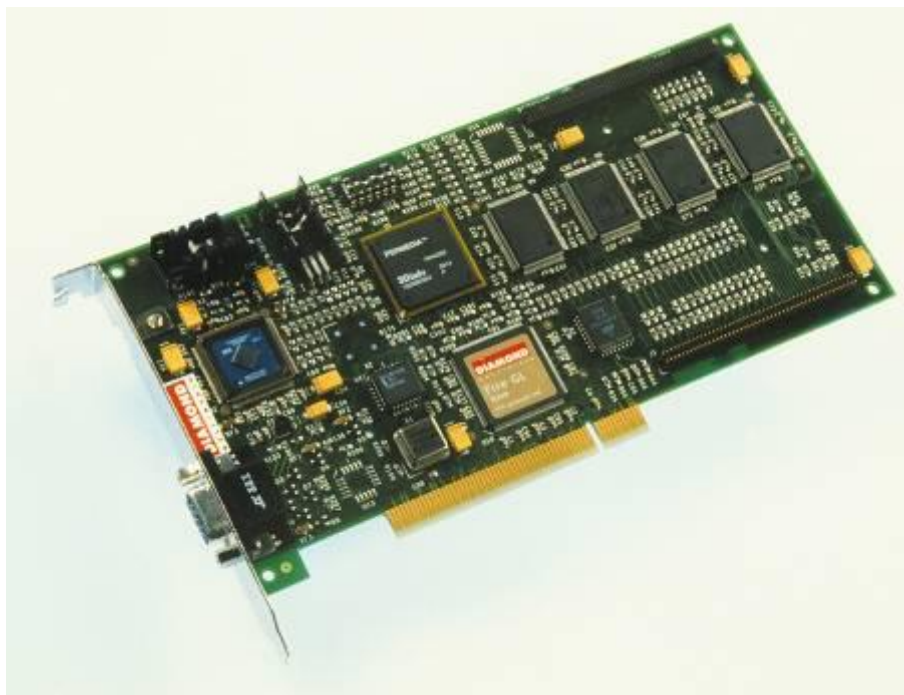

Nedostaci CRT tehnologije

- Velika potrošnja struje
- Velike dimenzije po dubini i velika težina
- Nejednaka oštrina i boje na različitim delovima ekrana
- Jako emagnetno polje izaziva neželjenu elektromagnetsku radijaciju

DISPLEJI SA TEČNIM KRISTALOM

- Tečni kristali su skoro potpuno transparentne materije
- Kada je pod naponom menj se orijentacija molekula a time se menja i način propuštanja svetlosti

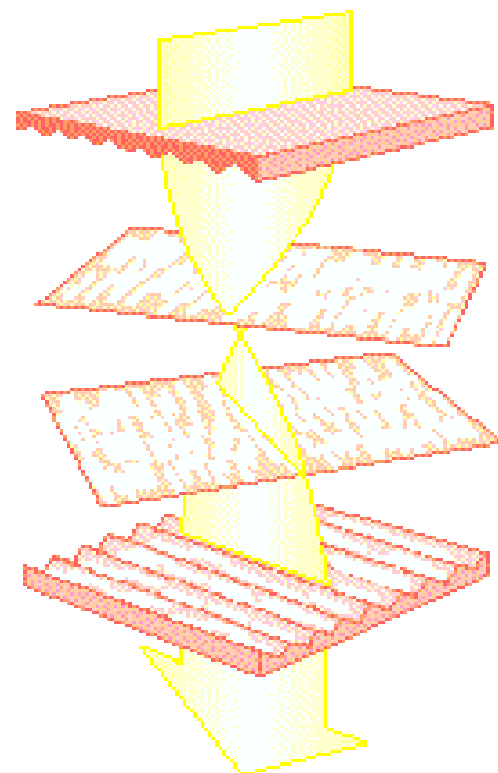

Dve tehnologije proizvodnje:

- dual-scan twisted nematic (DSTN) – jeftina
- thin film transistor (TFT) – visoki kvalitet



DISPLEJI SA TEČNIM KRISTALOM

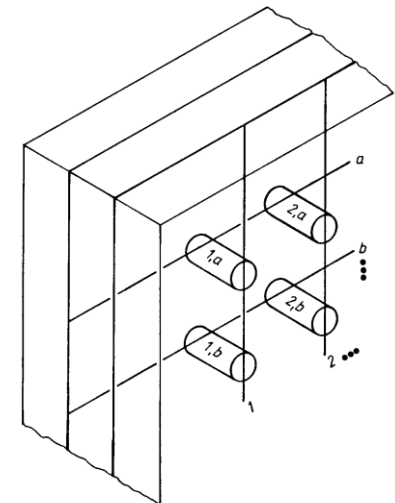
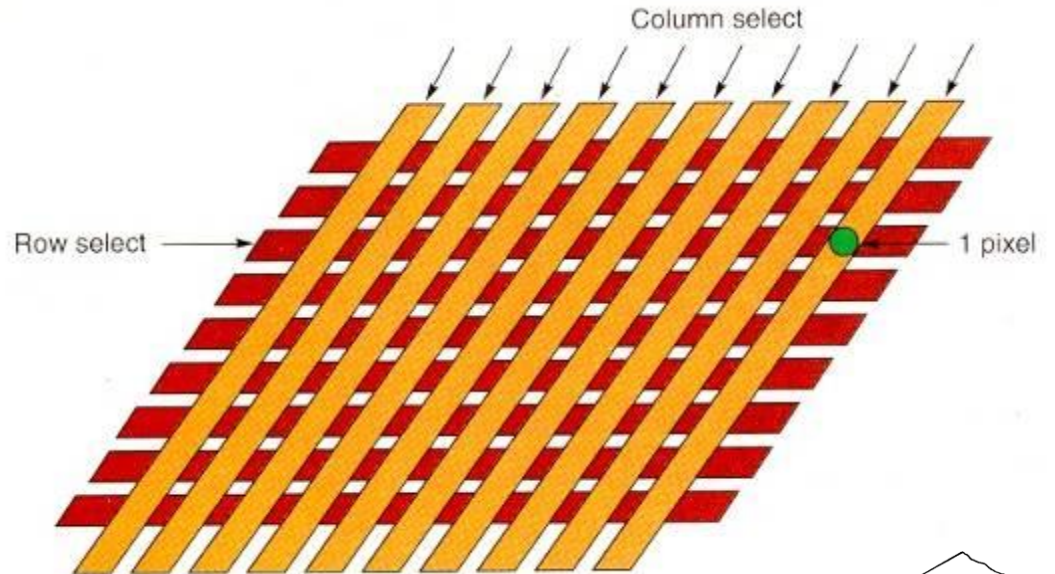

Samsung LCD TFT LTM170EU

17.0"

1,280 x 1,024

Veličina piksela (mm) 0.264

Broj boja 16.7M

Kontrast 1,000:1

Osvetljenje (cd/m²) 300

Vreme odziva (pri 25°C) 5 ms

Ugao vidljivosti (U/D/L/R) 80/80/80/80 °

Težina 2,200 kg



UREĐAJI ZA EMITOVANJE PODATAKA

